

Driveway Lite

Cat. No. DWL

[Click here for specifications on this luminaire](#)

[Return to main index](#)



A luminaire designed to mount flush with the level of the driveway, pathway, hotel floors or building foyer. A 'Flush Fit' lens stops water pooling and depositing dirt on the lens. There is no lip to trip over. The Driveway Lite is supplied with a mounting canister that facilitates ease of installation. The luminaire can be driven over or walked upon without damaging it. Designed so the lamp can be angled up to 20 degrees directed at a bush, tree, or the outside of a building, etc., without the need to remove the luminaire from the mounting canister due to the vandal-resistant three allen head screw fixing system which attaches the flange to the body of the luminaire. This luminaire has a solid bronze or 316 stainless steel flange with a powder coated black body.

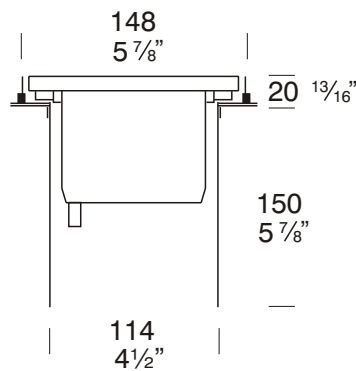

Ordering Information

Luminaire Type

DWL - Driveway Lite

Flange Option

BZ - Bronze
SS - 316 Stainless Steel

Body

Black only

Accessories

CJK150 - Cable Joint Kit
HCR - Hex Cell Louver
LLFR - Frosted Lens

Ordering Example: DWL BZ - Driveway Lite with Bronze Flange

LLFR - Frosted Lens

(Accessories ordered separately)



FACTORY: Ph: 64-9-528 9471 Fax: 64-9-528 9361.

USA: Ph. 310 560 7310 Fax. 1 877 692 4589.

hunza@hunza.co.nz www.hunza.co.nz

Specifications may change without notice.

130 Felton Mathew Ave, Glen Innes, Auckland, New Zealand.

3237 Long Island St, W. Sacramento, California 95691, USA.

Manufactured in New Zealand.

Ver 1.2

© 2004 Hunza Holdings Ltd

Luminaire Construction

Body:

Cast from virgin high corrosion resistant CC401 low copper aluminium alloy, with chromate substrate and high UV resistant black polyester powder coat.

Flanges:

The flange is attached to the body by three 316 stainless steel allen head anti vandal screws and is available in either -

Solid bronze -150mm (6") bar.

Solid 316 Stainless Steel -150mm (6") rod.

Mounting

Supplied with a mounting canister for casting in concrete to facilitate ease of installation. The luminaire can be driven over or walked upon without damaging it. Maximum drive over speed 10 km/h (6 mph) and weight 1500 kg (3300lbs).

Features

Lens:

12mm (½") flush fit clear tempered shatter resistant glass.

Life Time Warranty.

Gasket:

Nytrol 220c (428^of).

Lamp Holder:

GU5.3 350^oc (662^of) ceramic multi contact lamp holder with 250^oc (480^of) teflon cables. Lamp holder can be rotated 360^o and angled up to 20^o.

Accessories:

Cable Joint Kit (Cat. CJK150).
Not approved for USA / Canada.

Frosted Lens (Cat. LLFR).

Hex Cell Louver (Cat. HCR).

Standards

IP66



UL1838

Luminaire Weight

Bronze 1.950kg (4lb 4oz)
316 Stainless 1.900kg (4lb 3oz)

Power Supply

HUNZA[®] Inground or Wall Mount
Transformer: not included.

USA and Canada:

HUNZA[®] Wall Mount Transformer:
not included.

Luminaire: supplied with

MR16 GU5.3 20, 35 or 50 watt
lamp max.

USA and Canada:

MR16 GU5.3 20 watt lamp max.

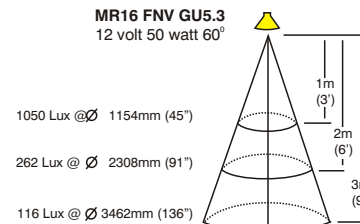
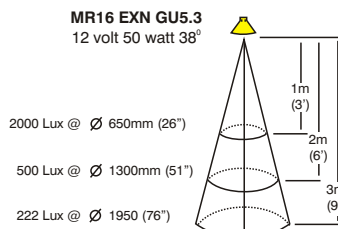
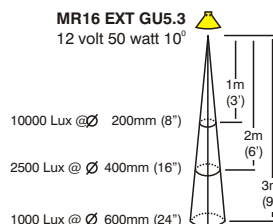
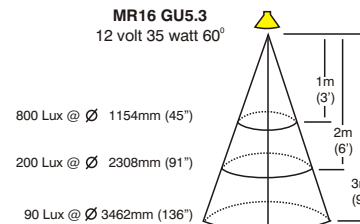
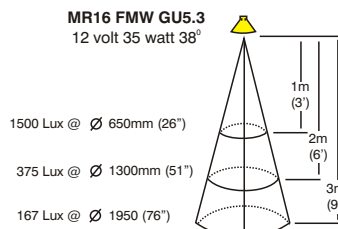
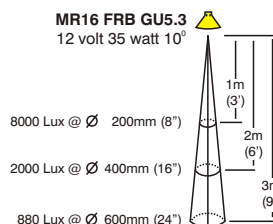
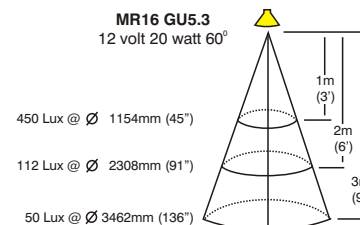
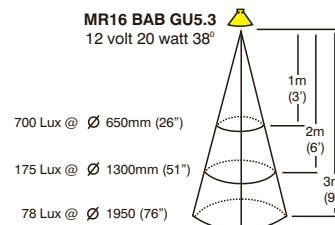
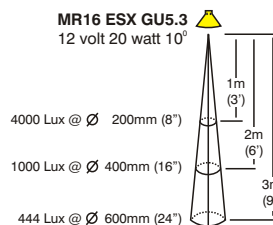

FACTORY: Ph: 64-9-528 9471 Fax: 64-9-528 9361.

USA: Ph. 310 560 7310 Fax. 1 877 692 4589.

hunza@hunza.co.nz www.hunza.co.nz

Specifications may change without notice.

130 Felton Mathew Ave, Glen Innes, Auckland, New Zealand.

3237 Long Island St, W. Sacramento, California 95691, USA.

Manufactured in New Zealand.

© 2004 Hunza Holdings Ltd

Ver 1.2