

Hanging Lite

Cat. No. HL

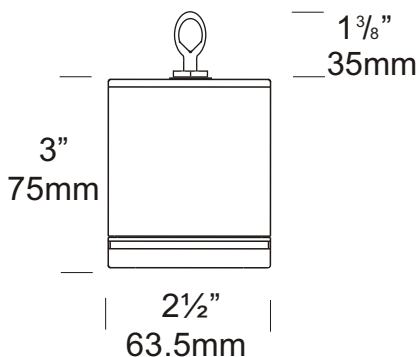

The Hanging Lite is a single spotlight which can be easily hung from high vantage points, including trees, fences and over-hangs, providing a dramatic wash lighting effect. The luminaire is machined from a choice of 10mm thick aluminium with a UV stable powder coated finish, solid copper or 316 stainless steel with a clear, tempered, flush glass lens and high temperature silicon gaskets. Comes standard with a 3 metre cable.



Ordering Information

Luminaire Type

HL - Hanging Lite

Material/Finish

BK - Black
 BZ - Bronze
 GN - Green
 STAR - Silver Star
 COP - Copper
 SS - 316 Stainless Steel

Accessories

CJK150 - Cable Joint Kit
 LENSSTEPF - Frosted Lens
 GG - Glare Guard
 HCL - Hex Cell Louvre
 HSCSS - Hanging Lite Chain
 316 Stainless Steel

For an alternative LED option start at page 10.4

Ordering Example: HL BK - Hanging Lite in Black

CJK150 - Cable Joint Kit

(Accessories ordered separately)



HUNZA™ PURE OUTDOOR LIGHTING

HUNZA FACTORY
 130 Felton Mathew Ave
 Glen Innes
 Auckland 1072
 New Zealand

Ph: 64-9-528 9471
 Fax: 64-9-528 9361
hunza@hunza.co.nz
www.hunza.co.nz

INTERNATIONAL CONTACTS:
www.hunza.co.nz/contacts.php

Specifications may change without notice.
 Manufactured in New Zealand.

© 2009 Hunza Holdings Ltd.

Ver 1.4

Luminaire Construction

CNC machined from one of the following metals:

High corrosion resistant 63.5mm (2½") x 10mm (25/64") aluminium.
End cap - solid aluminium 63.5mm (2½") rod, with chromate substrate and high UV resistant polyester powder coat

Colours Black, Bronze, Green, Silver Star.

Copper 63.5mm (2½") x 10mm (13/32"). End cap - solid copper 63.5mm (2½") rod.

316 Stainless Steel 9mm (11/32"). End cap - solid 316 stainless steel 63.5mm (2½") rod.

Features

Lens:

10mm (3/8") clear flush fit shatter resistant glass.

Life Time Warranty.

Gaskets:

Silicone, iron impregnated 220°C (428°F).

Lamp Holder:

GU5.3 - 350°C (662°F) ceramic multi contact lamp holder with 250°C (480°F) teflon cables.

Accessories:

Cable Joint Kit (Cat. CJK150).

Frosted Lens (Cat. LENSSTEPF).

Glare Guard (Cat. GG).

Hex Cell Louvre (Cat. HCL).

Hanging Lite Chain 316 Stainless Steel (Cat. HSCSS).

Standards

IP68  UL1838

Luminaire Weight

Alum .700kg (1lb 8oz)

Cop 1.470kg (3lb 3oz)

SS 1.160kg (2lb 9oz)

Power Supply

HUNZA™ Inground or Wall Mount
Transformer: not included.

USA and Canada:

HUNZA™ Wall Mount Transformer:
not included.

Luminaire: supplied with

MR16 GU5.3 20, 35 or 50 watt
lamp max.

LED - Refer sheet no. 10.4

USA and Canada:

MR16 GU5.3 20 watt lamp.

LED - Refer sheet no. 10.4

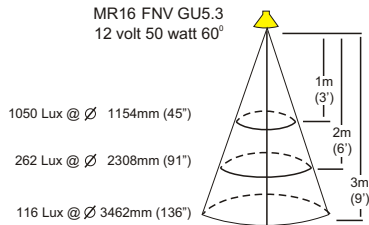
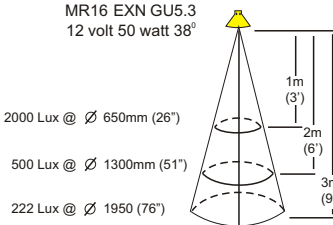
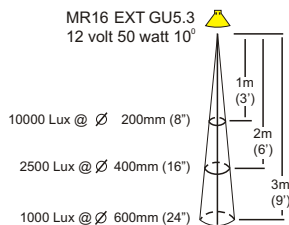
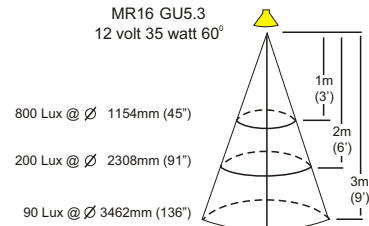
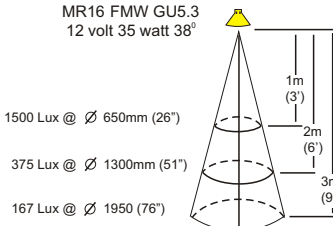
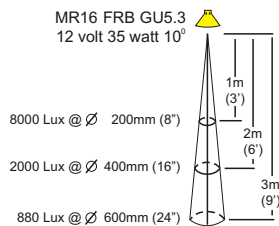
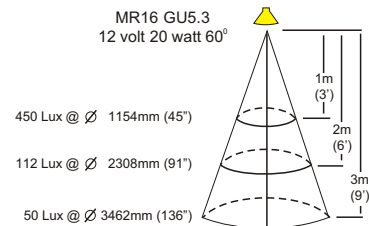
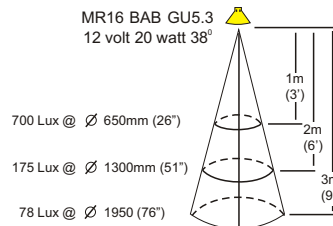
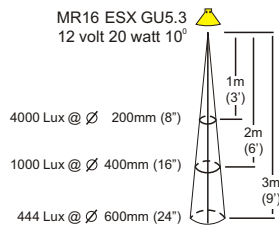

HUNZA™ PURE
OUTDOOR
LIGHTING

HUNZA FACTORY
130 Felton Mathew Ave
Glen Innes
Auckland 1072
New Zealand

Ph: 64-9-528 9471
Fax: 64-9-528 9361
hunza@hunza.co.nz
www.hunza.co.nz

INTERNATIONAL CONTACTS:
www.hunza.co.nz/contacts.php

Specifications may change without notice.
Manufactured in New Zealand.

© 2009 Hunza Holdings Ltd.

Ver 1.4