

Single Pole Lite Metal Halide

Cat. No. SPLMH20

Cat. No. SPLMH35



The Single Pole Lite Metal Halide is ideal for path lighting as well as tree lighting, and the head may be aimed downward to eliminate vertical light. The fitting has a single spotlight which can be aimed in any direction as it has a fully adjustable arm allowing 360 degree rotation and 0 - 90 degree elevation.

Metal Halide lamps are highly energy efficient light sources using less energy and out putting 2 - 3 times the light of a halogen lamp. This luminaire uses a MR16 GX10 lamp.

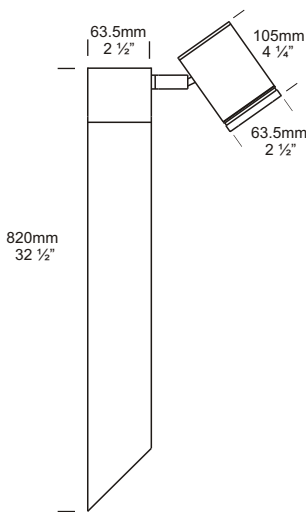

Ordering Information

Luminaire Type

SPLMH20 - Single Pole Lite Metal Halide 20watt
 SPLMH 35 - Single Pole Lite Metal Halide 35watt

Material/Finish

BK - Black
 BZ - Bronze
 GN - Green
 STAR - Silver Star
 COP - Copper
 SS - 316 Stainless Steel

Accessories

CJK150 - Cable Joint Kit
 LENSSTEPF - Frost Lens

Ordering Example: SPLMH20 COP - Single Pole Lite Metal Halide 20watt in Copper.

LENSSTEPF - Frosted Lens
 (Accessories ordered separately)

HUNZA™ PURE OUTDOOR LIGHTING

HUNZA FACTORY
 130 Felton Mathew Ave
 Glen Innes
 Auckland 1072
 New Zealand

Ph: 64-9-528 9471
 Fax: 64-9-528 9361
hunza@hunza.co.nz
www.hunza.co.nz

INTERNATIONAL CONTACTS:
www.hunza.co.nz/contacts.php

Specifications may change without notice.
 Manufactured in New Zealand.
 © 2009 Hunza Holdings Ltd.

Ver 1.4

Luminaire Construction

CNC machined from one of the following metals:

High corrosion resistant 63.5mm (2½") x 10mm (25/64") aluminium. End cap - solid aluminium 63.5mm (2½") rod, with chromate substrate and high UV resistant polyester powder coat - Colours Black, Bronze, Green, Silver Star.

Copper 63.5mm (2½") x 10mm (13/32"). End cap - solid copper 63.5mm (2½") rod.

316 Stainless Steel 63.5mm x 9mm End cap - solid 316 stainless steel 63.5mm (2½") rod.

Mounting

The Single Pole Lite is directly mounted into the earth or concrete.

Features

Lens:
10mm (3/8") clear 'flush fit' shatter resistant glass. Life Time Warranty.

Gaskets:
Silicone, iron impregnated 220°C (428°F).

Lamp Holder:
GX10 - 350°C (662°F) ceramic multi contact lamp holder with 250°C (480°F) teflon cables.

Accessories:
Cable Joint Kit (Cat. CJK150).
Frosted Lens (Cat. LENSTEPF).

Swivel:
Aluminium and Copper luminaires 360° rotation and 0 - 90° elevation, solid brass with anti rust spring.

Stainless Steel luminaires 360° rotation and 0 - 90° elevation, full 316 stainless steel construction.

Standards

AS/NZS 60598 2.2 IP66



UL1598

Luminaire Weight

Alum 2.00kg (4lb 6oz)
Cop 3.20kg (7lb 0oz)
SS 3.06kg (6lb 11oz)

Power Supply

Ballast: Electronic built in 230 - 240 volt ac 50Hz.

USA and Canada:

Ballast: Electronic built in 120 volt ac 60Hz.

Luminaire: supplied with MR16 GX10 20 or 35 watt lamp.

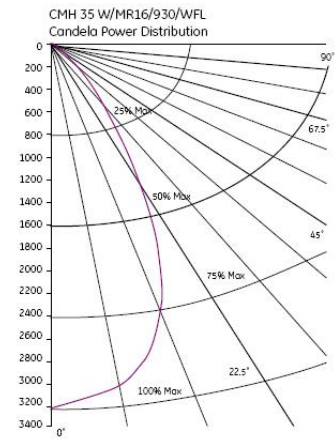
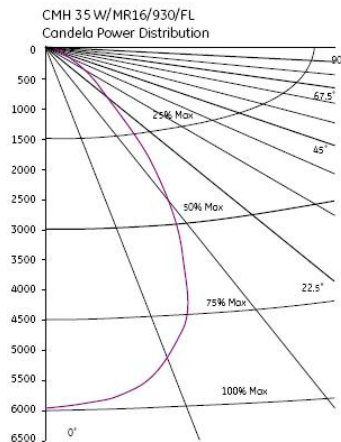
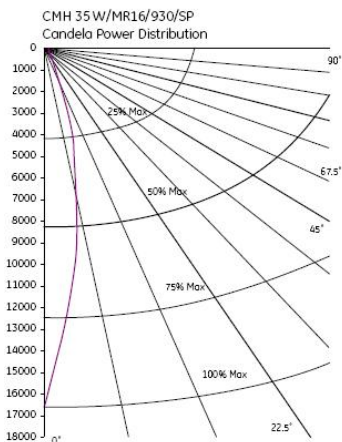
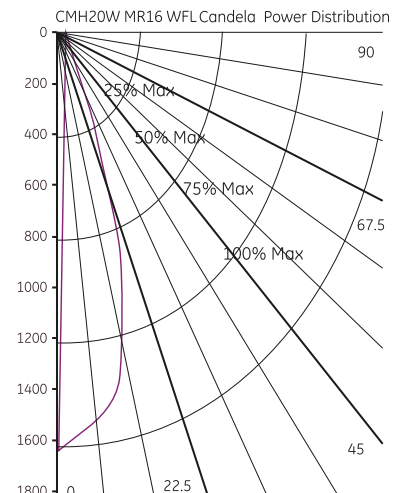
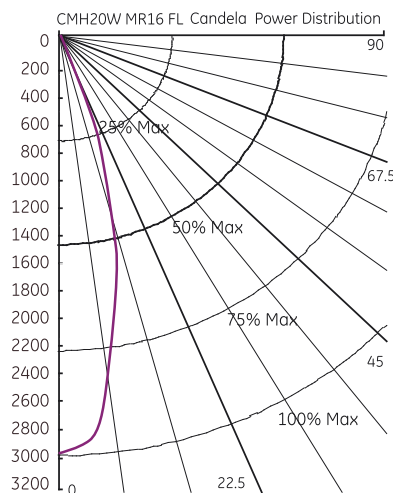
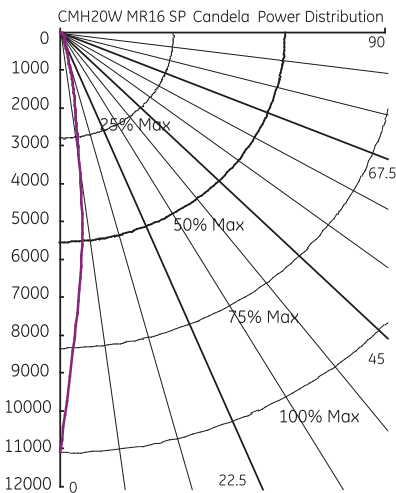

HUNZA™ PURE OUTDOOR LIGHTING

HUNZA FACTORY
130 Felton Mathew Ave
Glen Innes
Auckland 1072
New Zealand

Ph: 64-9-528 9471
Fax: 64-9-528 9361
hunza@hunza.co.nz
www.hunza.co.nz

INTERNATIONAL CONTACTS:
www.hunza.co.nz/contacts.php

Specifications may change without notice.
Manufactured in New Zealand.

© 2009 Hunza Holdings Ltd.

Ver 1.4