

Spike Spot Metal Halide

Cat. No. SSMH20
Cat. No. SSMH35

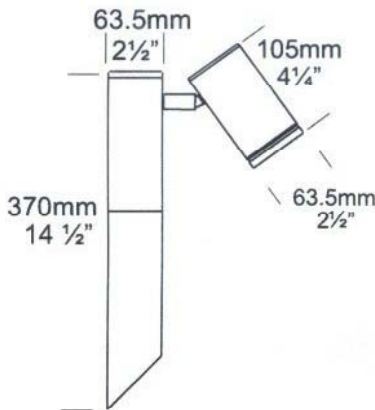

The Spike Spot Metal Halide is ideal for uplighting shrubs and small trees and is an excellent all-purpose garden light. Metal Halide lamps are highly energy efficient light sources using less energy and out putting 2 - 3 times the light of a halogen lamp. This luminaire can be easily aimed by angling the luminaire in the desired direction. This luminaire uses a MR16 GX10 20 or 35 watt lamp.



Ordering Information

Luminaire Type

SSMH20 - Spike Spot
Metal Halide 20watt
SSMH35 - Spike Spot
Metal Halide 35watt

Material/Finish

BK - Black
BZ - Bronze
GN - Green
STAR - Silver Star
COP - Copper
SS - 316 Stainless Steel

Accessories

CJK150 - Cable Joint Kit
LENSSTEPF - Frosted Lens
(Accessories ordered separately)



Ordering Example: SSMH20 COP - Spike Spot Metal Halide 20 watt
in Copper

HUNZA™ PURE
OUTDOOR
LIGHTING

HUNZA FACTORY
130 Felton Mathew Ave
Glen Innes
Auckland 1072
New Zealand

Ph: 64-9-528 9471
Fax: 64-9-528 9361
hunza@hunza.co.nz
www.hunza.co.nz

INTERNATIONAL CONTACTS:
www.hunza.co.nz/contacts.php

Specifications may change without notice.
Manufactured in New Zealand.

© 2009 Hunza Holdings Ltd.

Ver 1.4

Luminaire Construction

CNC machined from one of the following metals:

High corrosion resistant 63.5mm (2½") x 10mm (25/64") aluminium. End cap - solid aluminium 63.5mm (2½") rod, with chromate substrate and high UV resistant polyester powder coat

Colours Black, Bronze, Green, Silver Star.

Copper 63.5mm (2½") x 10mm (13/32"). End cap - solid copper 63.5mm (2½") rod.

316 Stainless Steel 63.5mm (2½") x 9mm (11/32"). End cap - solid 316 Stainless Steel 63.5mm (2½") rod.

Mounting

Mount directly into the earth.

Features

Lens:

10mm (3/8") clear 'flush fit' tempered shatter resistant glass.

Life Time Warranty on lens.

Gaskets:

Silicone, iron impregnated 220°C (428°F).

Lamp Holder:

GX10 - 350°C (662°F) ceramic multi contact lamp holder with 250°C (480°F) teflon cables.

Accessories:

Cable Joint Kit (Cat. CJK150).

Frosted Lens (Cat. LENSSTEPF).

Standards

AS/NZS 60598.2.2 IP66



UL1598

Luminaire Weight

Alum 1.555kg (1lb 1oz)

Cop 1.240kg (2lb 11oz)

SS 1.080kg (2lb 6oz)

Power Supply

Ballast built in: 230 - 240 volt ac 50Hz.

USA and Canada:

Ballast built in: 120 volt ac 60Hz.

Luminaire: supplied with MR16 GX10 20 or 35 watt lamp.

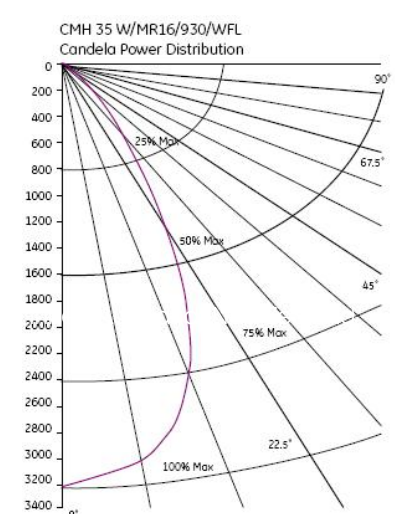
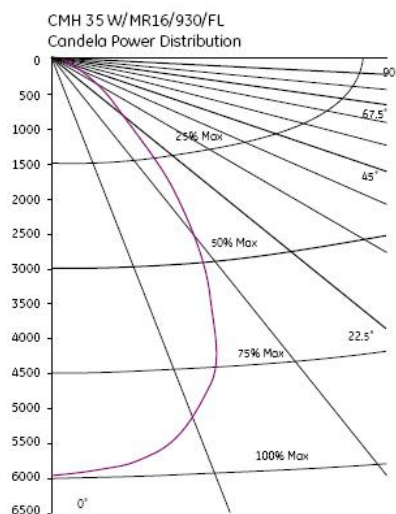
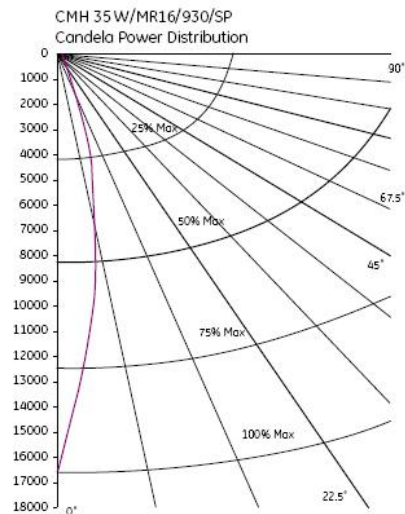
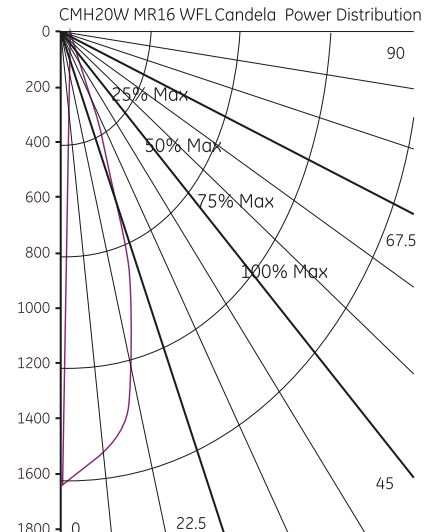
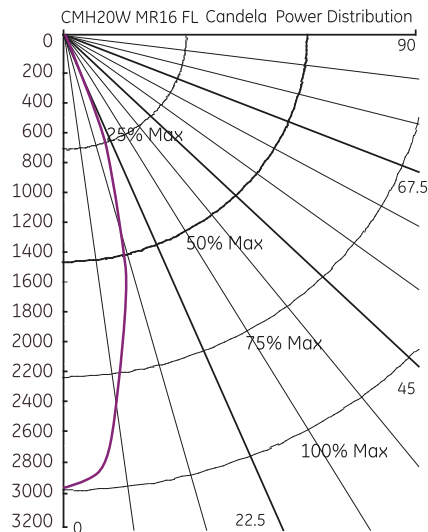
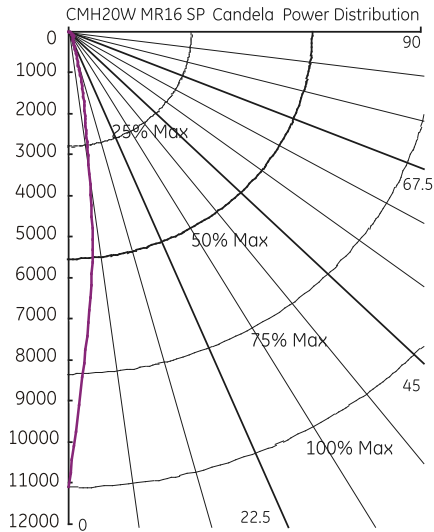

HUNZA™ PURE OUTDOOR LIGHTING

HUNZA FACTORY
130 Felton Mathew Ave
Glen Innes
Auckland 1072
New Zealand

Ph: 64-9-528 9471
Fax: 64-9-528 9361
hunza@hunza.co.nz
www.hunza.co.nz

INTERNATIONAL CONTACTS:
www.hunza.co.nz/contacts.php

Specifications may change without notice.
Manufactured in New Zealand.

© 2009 Hunza Holdings Ltd.

Ver 1.4