

Twin Pole Lite Metal Halide

Cat. No. TPLMH20
Cat. No. TPLMH35



The Twin Pole Lite Metal Halide has two spotlights aimed in two entirely different directions. The fitting has adjustable arms which allow 360 degree rotation and 0 - 90 degree elevation. This luminaire is ideal for path lighting as well as tree lighting and the head may be aimed downward to eliminate vertical light.

Metal Halide lamps are highly energy efficient light sources using less energy and out putting 2 - 3 times the light of a halogen lamp. This luminaire uses a MR16 GX10 20 or 35 watt lamp.

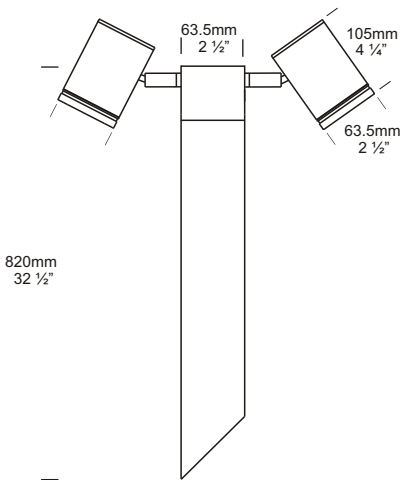

Ordering Information

Luminaire Type

- TPLMH20 - Twin Pole Lite Metal Halide 20watt
- TPLMH35 - Twin Pole Lite Metal Halide 35watt

Material/Finish

- BK - Black
- BZ - Bronze
- GN - Green
- STAR - Silver Star
- COP - Copper
- SS - 316 Stainless Steel

Accessories

- CJK150 - Cable Joint Kit
- LENSSTEPF - Frost Lens

Ordering Example: TPLMH20 COP - Twin Pole Lite Metal Halide 20 watt in Copper

LENSSTEPF - Frosted Lens
(Accessories ordered separately)

HUNZA™ PURE OUTDOOR LIGHTING

HUNZA FACTORY
130 Felton Mathew Ave
Glen Innes
Auckland 1072
New Zealand

Ph: 64-9-528 9471
Fax: 64-9-528 9361
hunza@hunza.co.nz
www.hunza.co.nz

INTERNATIONAL CONTACTS:
www.hunza.co.nz/contacts.php
Specifications may change without notice.
Manufactured in New Zealand.
© 2009 Hunza Holdings Ltd.

Ver 1.4

Luminaire Construction

CNC machined from one of the following metals:

High corrosion resistant 63.5mm (2½") x 10mm (25/64") aluminium. End cap - solid aluminium 63.5mm (2½") rod, with chromate substrate and high UV resistant polyester powder coat - Colours Black, Bronze, Green, Silver Star.

Copper 63.5mm (2½") x 10mm (13/32"). End cap - solid copper 63.5mm (2½") rod.

316 Stainless Steel 63.5mm x 9mm. End cap - solid 316 stainless steel 63.5mm (2½") rod.

Mounting

The Single Pole Lite is directly mounted into the earth or concrete.

Features

Lens:
10mm (3/8") clear 'flush fit' shatter resistant glass. Life Time Warranty.

Gaskets:
Silicone, iron impregnated 220°C (428°F).

Lamp Holder:
GX10 - 350°C (662°F) ceramic multi contact lamp holder with 250°C (480°F) teflon cables.

Accessories:
Cable Joint Kit (Cat. CJK150).
Frosted Lens (Cat. LENSSTEPF).

Swivel:
Aluminium and Copper luminaires 360° rotation and 0 - 90° elevation, solid brass with anti rust spring.
Stainless Steel luminaires 360° rotation and 0 - 90° elevation, full 316 stainless steel construction.

Stainless Steel luminaires 360° rotation and 0 - 90° elevation, full 316 stainless steel construction.

Standards

AS/NZS 60598 2.2 IP66



UL1598

Luminaire Weight

Alum 2.45kg (5lb 4oz)
Cop 4.40kg (9lb 8oz)
SS 4.00kg (8lb 8oz)

Power Supply

Ballast: Electronic built in 230 - 240 volt ac 50Hz.

USA and Canada:

Ballast: Electronic built in 120 volt ac 60Hz.

Luminaire: supplied with MR16 GX10 20 or 35 watt lamp.

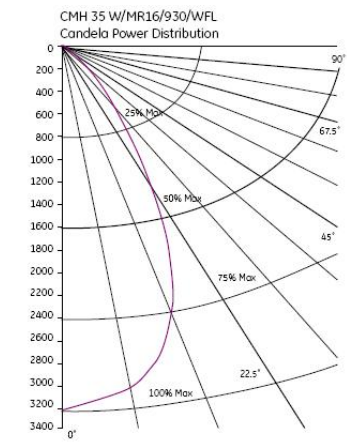
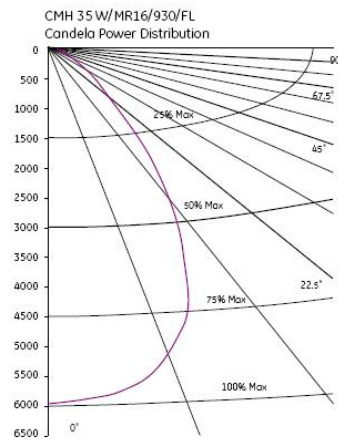
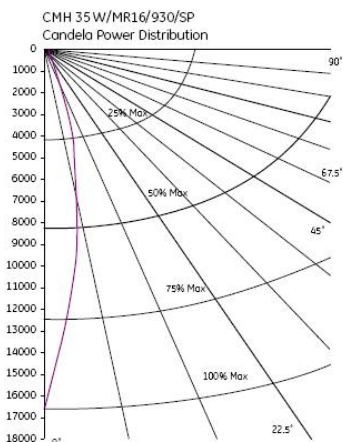
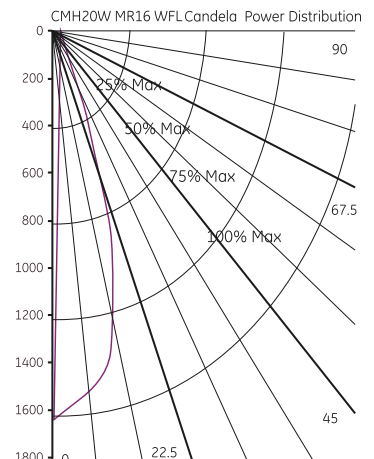
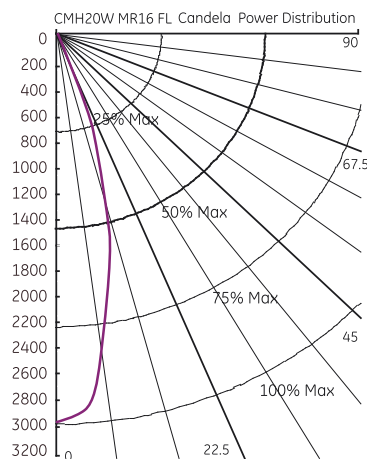
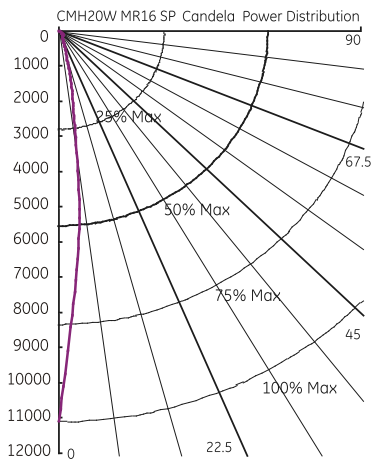

HUNZA™ PURE OUTDOOR LIGHTING

HUNZA FACTORY
130 Felton Mathew Ave
Glen Innes
Auckland 1072
New Zealand

Ph: 64-9-528 9471
Fax: 64-9-528 9361
hunza@hunza.co.nz
www.hunza.co.nz

INTERNATIONAL CONTACTS:
www.hunza.co.nz/contacts.php

Specifications may change without notice.
Manufactured in New Zealand.

© 2009 Hunza Holdings Ltd.

Ver 1.4